



Security Tech Germany

PPDF17000 / PPDF17520



Important notes and FAQs about this product and other products can be found on the website

www.abus.com

Version 1.0

*Original operating instructions in German language.
Keep for future use!*



Introduction

Dear Customer,

Thank you for purchasing this product.

ABUS Security Center hereby declares that the products PPDF17000 and PPDF17520 comply with the RED Directive 2014/53/EU. The device also complies with the requirements of the following EU Directives: EMC Directive 2014/30/EU and RoHS Directive 2011/65/EU. The full text of the EU Declaration of Conformity is available at the following Internet addresses:

www.abus.com/product/PPDF17000

To maintain this condition and to ensure safe operation, you as the user must observe these operating instructions!

Read through the complete operating instructions before commissioning the product, observe all operating and safety instructions!

All company names and product designations contained herein are trademarks of their respective owners. All rights reserved.

If you have any questions, please contact your installer or dealer!



Data storage is subject to country-specific data protection guidelines .

The installation of monitoring systems may be prohibited or regulated by law in certain countries. Before the installation of the system, the operator must ensure that the monitoring is within the legal framework.

Data protection notice

The operator is responsible for the legally compliant use of the product in accordance with the GDPR as the responsible entity.



Warning in the sense of § 201 StGB:

Whoever unauthorizedly records the non-publicly spoken word of another on a sound carrier and uses such a recording or makes it accessible to a third party can be punished with imprisonment or a fine!

Likewise can be punished, who listens in unauthorized to the non-publicly spoken word of another not intended for his knowledge with a listening device or communicates the recorded or listened non-publicly spoken word of another in the wording or its essential content publicly.



Disclaimer

These operating instructions have been prepared with the greatest care. Should you nevertheless notice any omissions or inaccuracies, please notify us in writing at the above address.

ABUS Security Center GmbH assumes no liability for technical and typographical errors and reserves the right to make changes to the product and operating instructions at any time without prior notice.

ABUS Security Center shall not be liable or responsible for any direct or indirect consequential damages arising in connection with the equipment, performance, and use of this product. No warranty of any kind is made with respect to the contents of this document.

Safety instructions

Intended use

Use the device exclusively for the purpose for which it was built and designed! Any other use is considered improper!

Important safety instructions

General

Before using the device for the first time, please read the following instructions carefully and observe all warnings even if you are familiar with handling electronic devices.

In case of damage caused by non-observance of these safety instructions, the warranty claim expires. We accept no liability for consequential damage!

Power supply

Operate this device only from a power source that supplies the mains voltage specified on the nameplate. If you are not sure which power supply you have, contact your power supply company. Disconnect the device from the mains power supply before carrying out any maintenance or installation work. The device is only completely disconnected from the mains power supply when the power supply unit is removed. To prevent fire hazard, the power plug of the device should always be disconnected from the mains socket when the device is not in use for a longer period. Before a storm and / or thunderstorm with danger of lightning, please disconnect the device from the mains or connect the device to a UPS. Avoid overloading power outlets, extension cords and adapters, as this may result in a fire or electric shock.

Cable

Always grasp all cables by the plug and do not pull on the cable itself. Never handle the power cord with wet hands as this may cause a short circuit or electric shock. Do not place the device, pieces of furniture or other heavy objects on the cables and make sure that they are not bent, especially at the plug and the connection sockets. Never tie a knot in a cable or tie it with other cables. All cables should be laid so that no one steps on them or is obstructed.

A damaged power cord can cause a fire or electric shock. Check the power cord from time to time. Do not modify or tamper with the power cord and power plug. Do not use adapter plugs or extension cords that do not comply with applicable safety standards, and do not tamper with the power and power cords.

Children

Keep electrical devices out of the reach of children! Never allow children to use electrical devices unsupervised. Children cannot always recognize possible dangers correctly. Small parts can be life-threatening if swallowed. Also keep the packaging films away from children. There is a danger of suffocation! This device does not belong in the hands of children. Springy parts can jump out if used improperly and cause injuries (e.g. eyes) to children.

Monitoring

The commissioning of monitoring equipment may be prohibited or regulated by law in certain countries.

Before commissioning the plant, the operator must ensure that the monitoring is within the legal framework.

Data protection notice

The operator is responsible for the legally compliant use of the product in accordance with the GDPR as the responsible entity.

Installation site Operating environment

Do not place heavy objects on the device.

The device is not designed for operation in rooms outside the specified operating temperature range or humidity range or excessive dust. For an exact specification, check the technical data of the individual devices. Ensure that there is always sufficient ventilation, that no direct heat sources act on the device, that no direct sunlight or strong artificial light falls on devices for indoor use, that the device is not located in the immediate vicinity of magnetic fields (e.g. loudspeakers), that no open fire sources (e.g. burning candles) on or near the device, avoid contact with splashing and dripping water on indoor devices and aggressive liquids, do not operate the device near water, in particular never submerge the device (do not place objects filled with liquids, e.g. vases or drinks, on or near the device), no foreign bodies penetrate, the device is not exposed to strong temperature fluctuations, otherwise humidity can condense and lead to electrical short circuits, the device is not exposed to excessive shocks and vibrations.

Unpacking

While unpacking the device, handle it with extreme care.

Packaging and packaging aids are recyclable and should always be recycled.

In case of possible damage to the original packaging, first check the device. If the device is damaged, return it with packaging and inform the delivery service.

Commissioning

Observe all safety and operating instructions before initial start-up!

⚠ Improper and amateurish work on the power grid or house installations pose a danger not only to yourself, but also to other people.

Maintenance and care

⚠ Disconnect the device from the mains for maintenance work or cleaning!

Maintenance

Have all maintenance work performed only by qualified personnel. Never open the housing of the device or accessories unless required to do so. Opening the device is only permitted for the following applications:

- Mounting the device, inserting a storage medium (SD card or hard disk), accessing essential functions (reset button or WPS button).

Cleaning

Clean the housing of the device only with a damp cloth. Do not use solvents, methylated spirits, thinners or other aggressive substances:

Gently rub the surface with the cotton cloth until it is completely dry.

- Dusty devices must be cleaned. Dust deposits in the air slots can be vacuumed or blown out. If necessary, the dust can be removed with a brush.
- The surface can be cleaned using a cloth lightly moistened with soapy water. Only use suitable microfiber cloths for high-gloss surfaces.
- Make sure that no water gets into the inside of the device!
- Do not clean the device in the dishwasher!
- Do not use any sharp, pointed, abrasive, corrosive cleaning agents or hard brushes!
- Do not use chemicals!
- Do not clean the device with easily flammable liquids!

Disposal



Attention: The EU Directive 2012/19/EU regulates the proper return, treatment and recycling of used electronic equipment. This symbol means that in the interest of environmental protection, the device must be disposed of at the end of its service life in accordance with the applicable legal regulations and separately from household or commercial waste. The disposal of the old device can be carried out via corresponding official collection points in your country. Follow the local regulations when disposing of the materials. For further details on take-back (also for non-EU countries), please contact your local administration. Separate collection and recycling conserves natural resources and ensures that all health and environmental regulations are met when recycling the product. Permanently installed batteries and rechargeable batteries must be returned with the device to the official collection points for waste electrical equipment.

Notes on handling batteries/rechargeable batteries
Replacement of the installed batteries may only be carried out by ABUS Technical Support! There are no serviceable parts inside the device.

Please note that all types of rechargeable batteries can explode or catch fire if handled improperly. This can lead to severe burns and injuries. Therefore, observe and avoid the following points:

- Do not burn, disassemble, puncture or damage the batteries.
- The battery/battery contacts must not be short-circuited.
- The batteries must not come into contact with water.
- The batteries must not be directly exposed to any heat source or sunlight and must not be stored in any place with very high temperature.
- Leaked or damaged batteries/battery packs can cause burns if they come into contact with the skin. In this case, use suitable protective gloves.
- Make sure that batteries/battery packs do not get into the hands of children. Children could put them in their mouths and swallow them. This can lead to serious damage to health. In this case, consult a doctor immediately!

Important note on the disposal of batteries/rechargeable batteries



Lithium batteries and battery packs may only be returned to the collection points when discharged! Please take precautions against short circuits (e.g. by insulating the terminals with adhesive tape). Batteries with this mark do not contain harmful substances such as cadmium, lead and mercury. Nevertheless, according to the Battery Ordinance, used batteries must not be disposed of in household waste. To protect natural resources and promote recycling of materials, separate batteries from other waste and take them to your local recycling system. Additional labeling with the chemical symbols for Hg, Cd or Pb means that the battery contains mercury, cadmium or lead in quantities exceeding the limits of EU Directive 2006/66/EC. If batteries are not disposed of properly, these substances may endanger human health or the environment.

Content

1. Scope of delivery	6
2. Hardware description	6
2.1. PPDF17000 - PPDF17520 camera	6
2.2. PPDF17000 - Monitor	7
3. Description of the hardware functions	8
3.1. LED behavior	8
3.2. Audio transmission	8
3.3. Factory settings / Reset	8
4. Assembly / Installation	9
4.1. PPDF17000 - Monitor	9
4.2. PPDF17000 - PPDF17520 camera	9
4.3. Teach in camera	11
5. Compatibility	11
6. Local user interface	11
6.1. Operation and live display	11
6.2. Live indicators	12
6.3. Live menu bar	13
6.4. Main menu	14
6.5. Recordings	15
6.6. System settings	17
6.7. Recording settings	18
6.8. Camera overview	19
6.9. Camera settings	20
6.10. Manage system	22
7. FAQs	23

1. Scope of delivery

PPDF17000

1x	7" EasyLook Monitor
1x	EasyLook Camera
2x	Power supply, 12V DC / 1 A (EU, UK)
2x	Antenna
1x	Mounting material
1x	Quick Guide
1x	Drilling template
1x	Safety instructions

PPDF17520

1x	EasyLook Camera
1x	Power supply, 12V DC / 1 A (EU, UK)
1x	Antenna
1x	Mounting material
1x	Quick Guide
1x	Drilling template
1x	Safety instructions

2. Hardware description

2.1. PPDF17000 - Camera PPDF17520

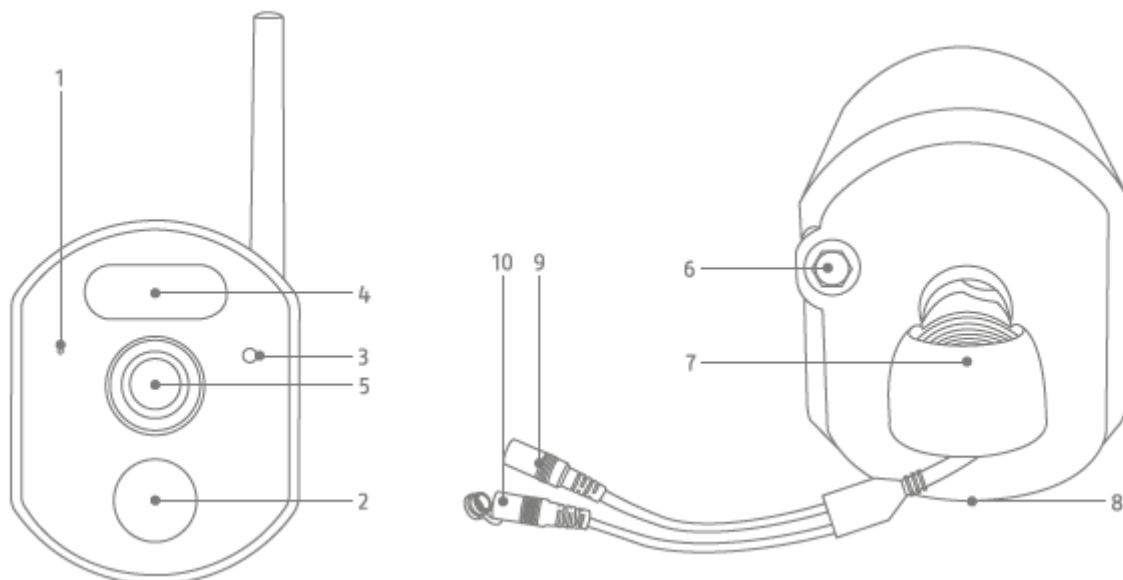

1	Microphone	2	Passive Infrared Sensor (PIR)
3	Light sensor	4	Infrared LEDs / Status LED
5	Lens	6	Antenna connector (RPSMA)*
7	Bracket	8	Loudspeaker
9	Power supply (12 V DC / 1 A)	10	Reset button

*Radio frequency: 2.4 GHz (max. transmission power 20dBm)

2.2. PPDF17000 - Monitor

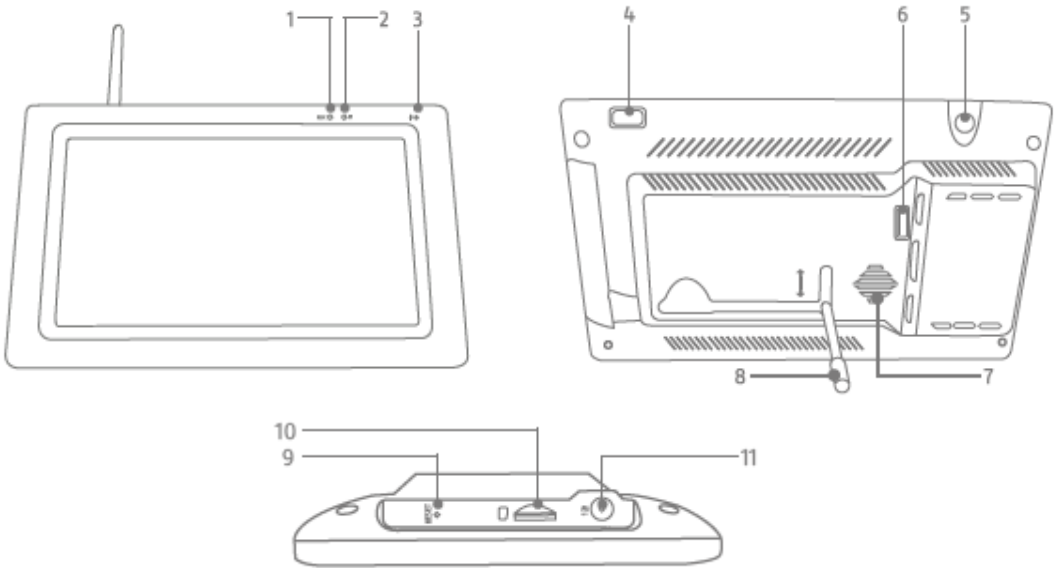

1	REC LED (flashes during recording)	2	Power LED
3	Microphone	4	On/Off switch
5	Antenna connector (RP-SMA)*	6	USB interface
7	Loudspeaker	8	Stand
9	Restart button	10	microSD card slot (max. 128GB)
11	Power supply (12V DC / 1A)		

*Radio frequency: 2.4 GHZ (max. transmit power 20 dBm)

3. Description of the hardware functions

3.1. LED behavior

PPDF17000 - Monitor

LED	State	Description
Power LED	Lights green	1. monitor connected to power 2. battery is fully charged
	Flashing green	Battery charges
	Flashes red	Battery level below 20%
Rec LED	Lights red	Not in record
	Flashes red	Recording in progress
	From	No SD card inserted

PPDF17000 - Camera PPDF17520

LED	State	Description
Status LED	Flashing fast Red (A beep sounds periodically during the pairing process).	Camera powered and in pairing mode
	Lights red	Connected to the monitor
	Flashes red	Camera not connected to the monitor
	From	Camera without power supply

3.2. Audio transmission

The monitor can receive an audio signal from one camera at a time. If several cameras are connected, only the audio signal from the selected camera is played back.

3.3. Factory settings / Reset

The camera can be reset via the reset button on the cable.

The monitor can be restarted via the restart button but is not reset. The factory settings can be loaded via the menu item "Manage system" -> "Factory settings".

There are two options here:

1. Easy reset (camera configurations are retained)
2. Reset all (All data will be reset to factory settings)

4. Assembly / Installation



ATTENTION!

During installation, the camera must be disconnected from the mains voltage.

4.1. PPDF17000 - Monitor

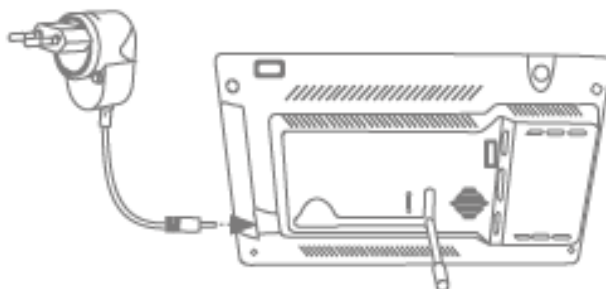

Fold out the stand and lock it by pushing the stand upwards. Then connect the included 12V DC / 1A power adapter. Turn on the monitor with the power switch and follow the monitor's instructions to complete the initial setup. Then connect the antenna to the monitor.

4.2. PPDF17000 - Camera PPDF17520

First check the signal strength at your location. Hold the camera (with the antenna screwed on) as precisely as possible at the desired location: Does the monitor show a smooth live image at the desired location? If this is the case, you can continue with the installation. Otherwise, reposition the camera or monitor until a smooth live image is obtained.

Option 1: Power supply flush-mounted

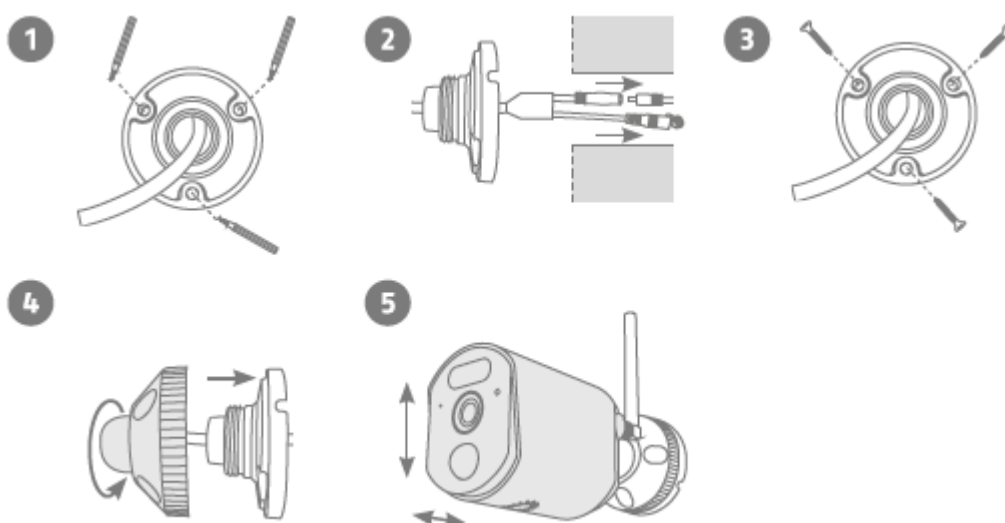

1. To start the installation, use the drilling template or unscrew the bracket to mark the required 3 drill holes with its wall plate at the desired location of the camera. Drill the 3 holes and insert the enclosed dowels.

2. Connect the power cable to the connector on the camera and feed the cables into the wall.
3. Fasten the wall plate of the bracket with the enclosed screws.
4. Insert the ball joint and put on the cover. The fixing ring is then screwed on a little.
5. Now align the camera to the roughly desired coverage area and tighten the fixing ring.

Option 2: Surface power supply

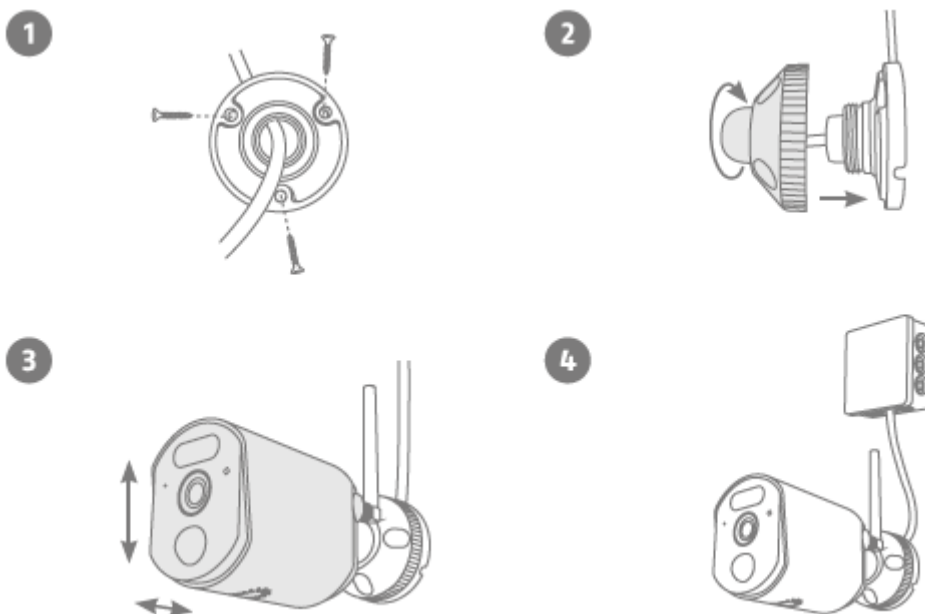

1. To start the installation, use the drilling template or unscrew the bracket to mark the required 3 drill holes with its wall plate at the desired location of the camera. Drill the 3 holes and insert the enclosed dowels. Feed the cable through one of the recesses in the wall plate. Fasten the wall plate of the mount to the wall using the enclosed screws.
2. Insert the ball joint and put on the cover. The fixing ring is then screwed on a little.
3. Now align the camera to the roughly desired coverage area and tighten the fixing ring.
4. Use a commercially available weatherproof installation box / junction box (width and height min. 105 mm, depth min. 35 mm) for a waterproof installation. Feed the camera cable into the box and run the cabling through there. For weatherproof installation of the box, follow its installation instructions.

4.3. Teach camera

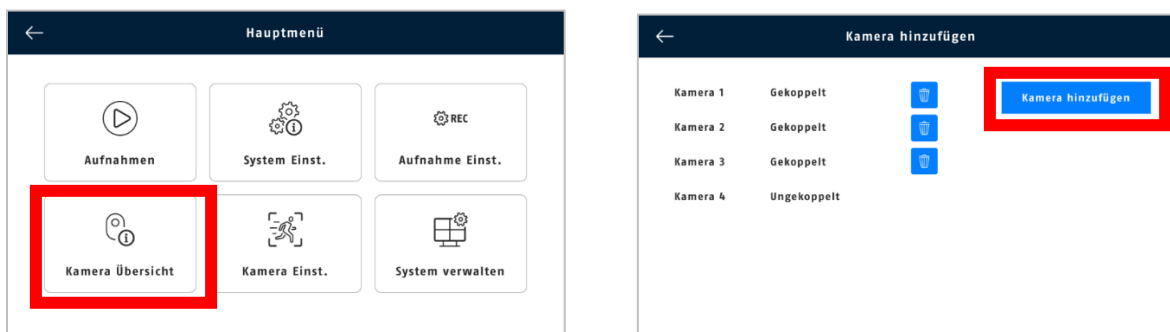

The camera supplied in the set is already paired with the monitor at the factory.

If you want to add a second camera, proceed as follows:

1. Tap the menu icon.
2. Tap on "Camera overview".
3. Supply the camera with power. The camera's status LED on the front panel should now light up continuously for 10 seconds, and then flash . After another 5 seconds, the camera will emit a pairing tone at regular intervals.
4. Click on "Add camera".
5. Now the LED should light up permanently for 3 seconds. After 10 sec. the camera is added to the monitor. After successful teach-in of the camera, an ID appears in the camera overview.
6. Then click on "Add stop ".
7. Exit the menu to see the live image of the camera on the monitor.

5. Compatibility

The monitor can be connected with up to 4 cameras. This means that the PPDF17000 set can be expanded with 3 cameras.

The cameras can be connected to **one** monitor and not to multiple monitors at the same time.

6. Local user interface

6.1. Operation and live display

The monitor can be operated via touch inputs.

Quad View:

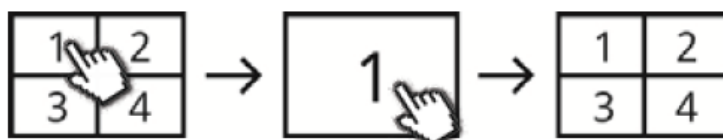

Double-click on a channel in the quad view to display it in full screen.

Double-click the full screen again to switch back to the quad view.

For further operation and setting use the menu bar.













6.2. Live indicators

Some information is available in the live view.







	<p>Selection</p> <p>By tapping the desired camera once, a red frame appears at the selected camera.</p> <p> The audio transmission always takes place only at the selected camera. To start the audio transmission of another camera, select the camera with a click.</p>
	<p>Signal strength display</p> <ul style="list-style-type: none">  Connection very good  Connection good  Connection low  No connection <p>If the connection is low or no connection is displayed, try to improve the connection by changing the antenna orientation of the camera and the monitor.</p> <p> If there is no improvement, we recommend our amplifier set TVAC17530: https://www.abus.com/product/TVAC17530</p>
<p>2022/06/18 11:23:34</p>	<p>Timestamp display</p> <p>Display of the current system time and date.</p>

6.3. Live menu bar

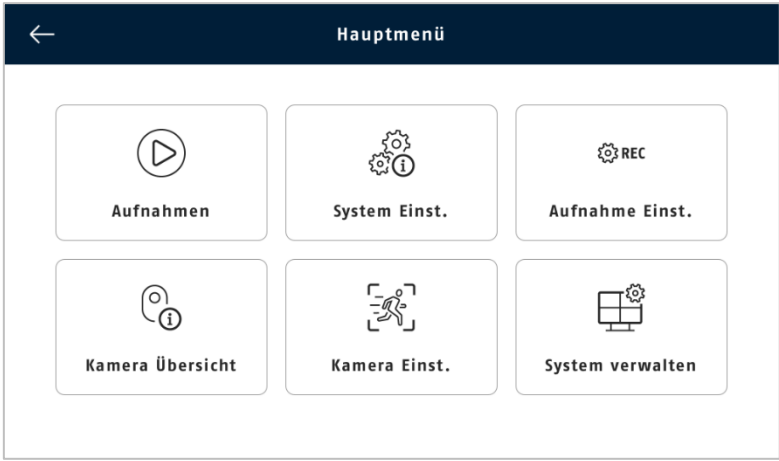
	Main menu
	Activate the zoom function
	Disable the zoom function
	Microphone deactivated
	Microphone activated
	Recordings
	Volume mute
	Volume low
	Volume medium
	Volume high
	The audio transmission always takes place only at the selected camera. To start the audio transmission of another camera, select the camera with a click.







6.4. Main menu

	<p>Back</p> <p>Please note that you can leave the individual menu items with the back button in the upper left corner. Changes will be saved automatically.</p>
---	--

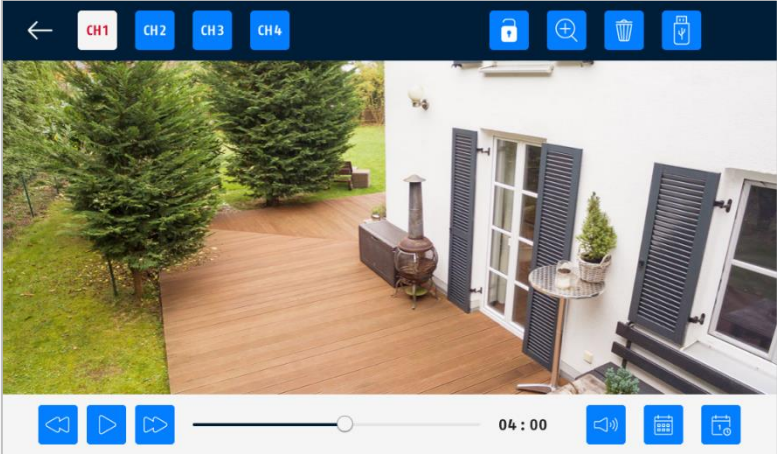

	
 Aufnahmen	<p>Recordings</p> <ul style="list-style-type: none"> ▪ Playback recordings ▪ Delete recordings ▪ Filter recordings ▪ Copy back-up of recordings to USB media
 System Einst.	<p>System settings</p> <ul style="list-style-type: none"> ▪ Language settings ▪ Time settings ▪ Camera audio settings ▪ Monitor volume settings ▪ Screensaver
 Aufnahme Einst.	<p>Recording settings</p> <ul style="list-style-type: none"> ▪ Recording schedule ▪ Memory status ▪ Ring memory
 Kamera Übersicht	<p>Camera overview</p> <ul style="list-style-type: none"> ▪ List of connected cameras ▪ Delete cameras ▪ "Add camera" mode
 Kamera Einst.	<p>Camera settings</p> <ul style="list-style-type: none"> ▪ Monitor sirens volume ▪ Open full screen on motion ▪ Motion detection ▪ Alarm when triggered ▪ Sensitivity ▪ Areas with motion detection ▪ Privacy zone masking

 <p>System verwalten</p>	<p>Manage system</p> <ul style="list-style-type: none"> ▪ System information ▪ Factory settings ▪ Monitor firmware update ▪ Camera update
---	--

6.5. Recordings

	
	<p>Select channel Select the desired camera channel for playback.</p>
	<p>Fix menu bar When this button is pressed, the menu bar is fixed during the playback of recordings.</p>
	<p>Zoom function Activate the zoom function Disable the zoom function</p>
	<p>Delete recording</p>
	<p>Back-up Creating a copy of the current recording when the USB media is connected</p>
	<p>Audio disabled Audio enabled</p>

	<p>Play previous recording</p> <p>Play recording</p> <p>Stop recording</p> <p>Play next recording</p> <p> Recordings can be fast-forwarded and rewind by moving the progress bar.</p>
	<p>Calendar to select the day</p> <p>Time Select</p>

<table border="1"> <tr> <td>16</td> <td>17</td> </tr> <tr> <td>23</td> <td>24</td> </tr> </table>	16	17	23	24	<p>Days with existing recordings are marked in red.</p>																								
16	17																												
23	24																												
<table border="1"> <tr> <td colspan="4">04 : 00 </td> </tr> <tr> <td>0 : 00</td> <td>01 : 00</td> <td>02 : 00</td> <td>03 : 00</td> </tr> <tr> <td>04 : 00</td> <td>05 : 00</td> <td>06 : 00</td> <td>07 : 00</td> </tr> <tr> <td>08 : 00</td> <td>09 : 00</td> <td>10 : 00</td> <td>11 : 00</td> </tr> <tr> <td>12 : 00</td> <td>13 : 00</td> <td>14 : 00</td> <td>15 : 00</td> </tr> <tr> <td>16 : 00</td> <td>17 : 00</td> <td>18 : 00</td> <td>19 : 00</td> </tr> <tr> <td>20 : 00</td> <td>21 : 00</td> <td>22 : 00</td> <td>23 : 00</td> </tr> </table>	04 : 00 				0 : 00	01 : 00	02 : 00	03 : 00	04 : 00	05 : 00	06 : 00	07 : 00	08 : 00	09 : 00	10 : 00	11 : 00	12 : 00	13 : 00	14 : 00	15 : 00	16 : 00	17 : 00	18 : 00	19 : 00	20 : 00	21 : 00	22 : 00	23 : 00	<p>By clicking on the arrow above, the hour selection can be expanded. The currently selected exposure is displayed in red.</p>
04 : 00 																													
0 : 00	01 : 00	02 : 00	03 : 00																										
04 : 00	05 : 00	06 : 00	07 : 00																										
08 : 00	09 : 00	10 : 00	11 : 00																										
12 : 00	13 : 00	14 : 00	15 : 00																										
16 : 00	17 : 00	18 : 00	19 : 00																										
20 : 00	21 : 00	22 : 00	23 : 00																										

6.6. System settings

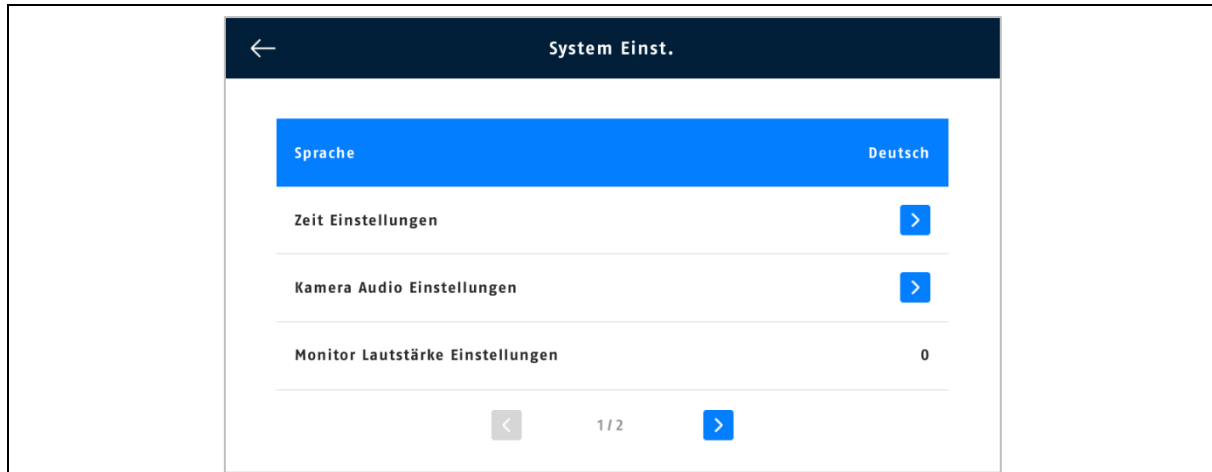

Language

Select the desired language here. (English, German, French, Dutch, Italian, Danish)

Time settings

Here you can set the current date and time.

Camera audio settings

Here you can define whether the respective camera should play back and record audio.

Monitor volume settings

Set the playback volume of recordings here.

Screensaver (page 2)

Select the on time of the screen saver.

6.7. Recording settings

← Aufnahme Einst.

Aufzeichnungszeitplan >

Speicher Status >

Ring Speicher 🟢

← Aufnahme Einst.

Aktivieren Sie 🟢

Kamera 1, 2, 3, 4

Tag der Woche ...

Uhrzeit 08 : 00 ~ 08 : 25

Recording schedule

Here you can set up to 4 schedules for activating the cameras' motion detection.

- To activate, the slider must be set to the right and be **green**
- Camera: Specify which camera should be affected by the schedule
- Set period using the days and time

 Schedule 1 is factory set as the default schedule (for the entire period). If this is deactivated, the cameras do not detect movements

Storage status





Here you can display the used and available storage space. In addition, the SD card can be formatted via this menu item.

Ring Buffer

If this function is activated, the oldest recordings are overwritten with newer ones as soon as the SD card is full. If the function is deactivated, no more exposures can be made when the SD card is full.

6.8. Camera overview

← Kamera hinzufügen

Kamera 1	Gekoppelt		
Kamera 2	Gekoppelt		
Kamera 3	Gekoppelt		
Kamera 4	Ungekoppelt		



Delete camera

Here you can disconnect connected cameras from the monitor.



A manual reset of the camera using the reset button is necessary for a reconnection.

Add camera

Here you can add more cameras to your set.

Supply the camera with power. Click Add Camera.

After the camera has been successfully taught-in, " Paired" is displayed for the next free camera.

Connecting is described in more detail in section 4.3.

6.9. Camera settings

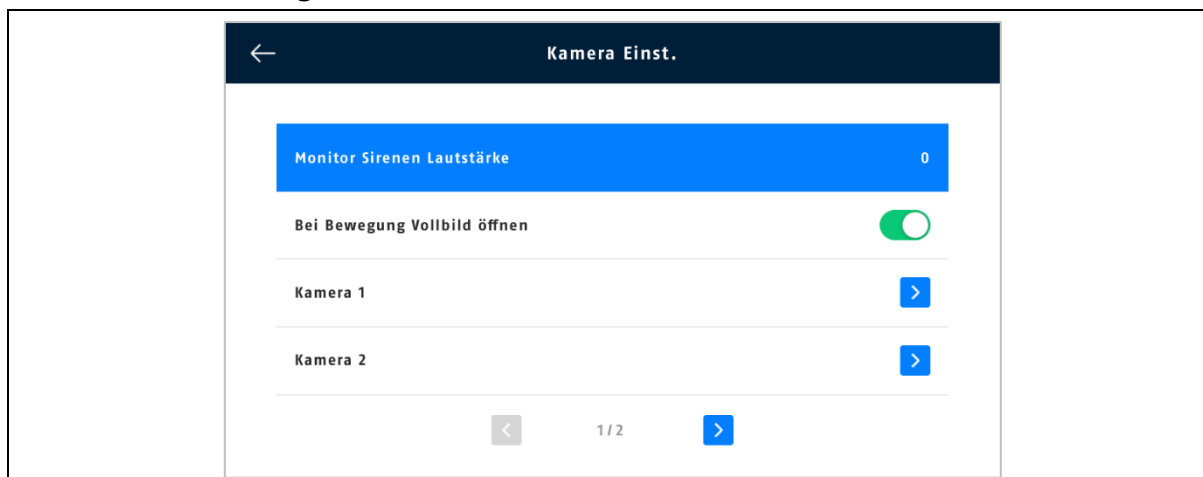

Monitor sirens volume

Set here the siren volume of the monitor in case of a trigger. (0 = Off)

Open full screen on motion

When motion is detected, the triggering camera is displayed in full screen.

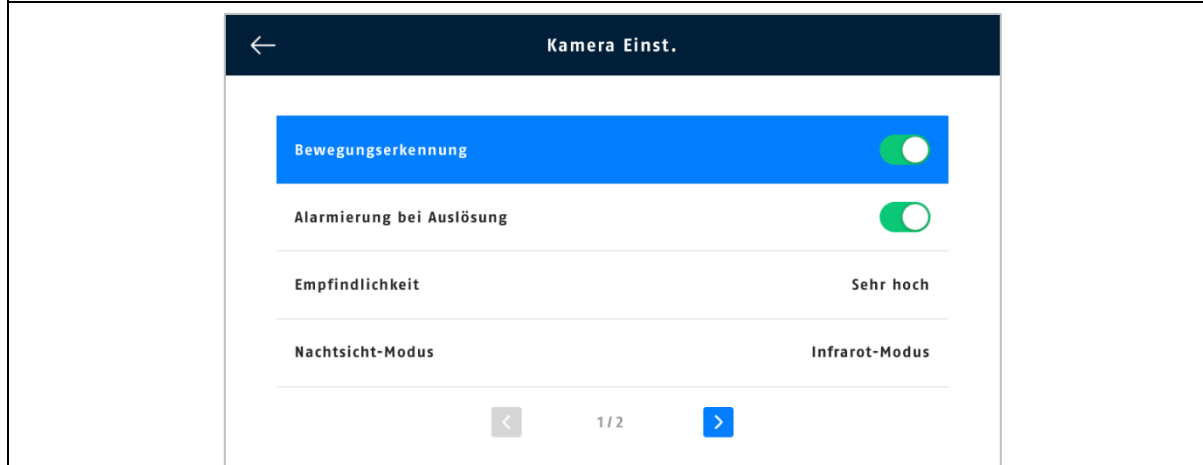

Motion detection

Switching on/off is done via the control slider (Green = On)

Alarm when triggered

Activates the siren on the monitor when motion detection is triggered

Sensitivity

Here you can adjust the sensitivity of the motion detection optimally to your monitored area. You can minimize unwanted false triggering by using less sensitive stages.

Areas with motion detection

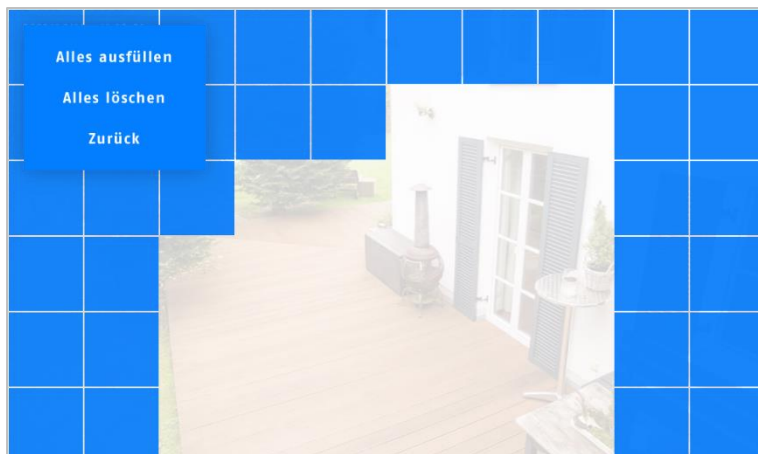

Here you can define the desired areas in which motion detection is desired. This helps you to minimize unwanted triggers. The areas marked in **blue** are the active areas. A recording is started there when triggered.

Privacy zone masking

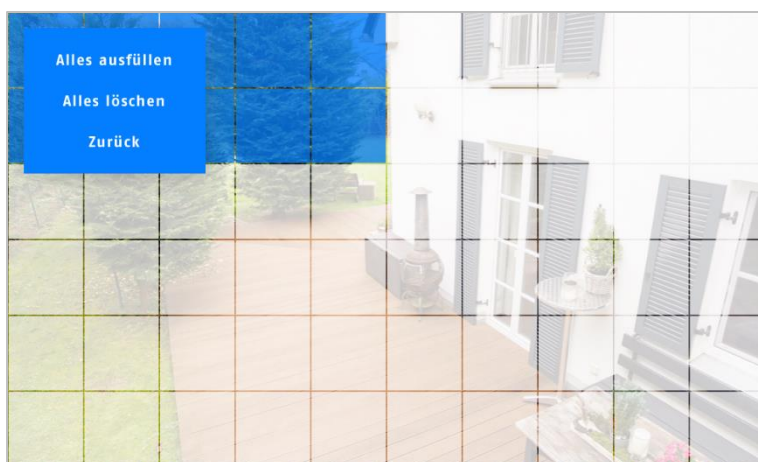

A preview of the live image and the privacy zone set up is displayed here. Drawing privacy zones is done directly in the preview area. You can activate up to 4 areas and place and customize them individually using drag and drop.



 Individually selected fields also count as a separate area. With four individually selected areas, the maximum number is already reached. If the number of areas is exceeded, the oldest area is deleted.

The drawn area is made unrecognizable in dark blue and is therefore not visible in the live image or in the recording.

Click "Back" in the upper left corner to save the settings.

To delete zones, click on Delete all zones and then on the check mark in the upper right corner.

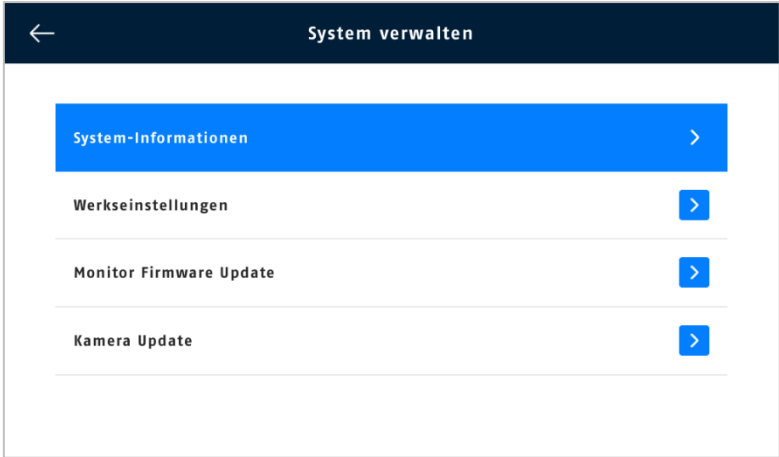
6.10. Manage system

<p>System information Device model Devices SN (serial number) B/W version (software version) Build time (creation date of the software)</p>
<p>Factory settings Simple reset (camera configurations are retained) Reset all (All data will be reset to factory settings)</p>
<p>Monitor firmware update Here you can update the monitor, provided that a new version is available on the ABUS homepage. Download the update, unzip it and save the .rom file on a USB stick. Plug the USB stick into the USB port on the back of the monitor. Now click on the "Local Update" button on the monitor. After the successful update, the monitor restarts after confirming the "Finish" button.</p> <p> Do not disconnect the monitor from the power during the update. Also, do not disconnect the USB flash drive from the monitor.</p>
<p>Camera update Select the desired camera and choose "Start".</p>

7. FAQs

No	Questions	Answers
1	What does it mean to pair monitor and camera and how does it work?	<p>Pairing establishes the exclusive, encrypted wireless connection between the monitor and camera.</p> <p>To connect a camera to the monitor, proceed as follows:</p> <ul style="list-style-type: none"> • Tap the menu icon. • Tap on "Camera overview". • Supply the camera with power. Now the status LED on the front of the camera should light up continuously for 10 seconds , and then flash . After another 5 seconds, the camera will emit a pairing tone at regular intervals. • Click on "Add camera". • Now the LED should light up permanently for 3 seconds. After 10 sec. the camera is added to the monitor. After successful teach-in of the camera, an ID appears in the camera overview. • Then click on "Stop adding". • Exit the menu to see the live image of the camera on the monitor.
2	What could be the causes that no image is displayed on the monitor?	<p>If you have no signal, please check the following:</p> <ul style="list-style-type: none"> • Is the camera connected to the mains (is the LED red)? • Is the monitor loaded? • Are the camera and the monitor connected (see question 1)? • Is the camera within range of the monitor? • Is the signal between camera and monitor disturbed?
3	What could be the causes that the device does not record when moving?	<p>Please check the following points:</p> <ul style="list-style-type: none"> • The sensitivity of the motion detection increases if necessary. • Whether the recording schedule is active • Whether motion detection is active
4	What could be the reasons for the device not recording even though a schedule has been set?	<p>Possible causes could be:</p> <ul style="list-style-type: none"> • Are the date and time set correctly? • Is an SD card inserted? Is the SD card full and the ring memory inactive? • Have you formatted the SD card? This must be formatted before the first use. • No movement was detected.
5	What could be the reasons for the camera not pairing to the monitor?	<p>Please check the following points:</p> <ul style="list-style-type: none"> • The camera has no power supply. • Is the camera in pairing mode? (After power is supplied, the status LED must flash and emit the pairing tone).